

Escalier droit - Bâtiment A

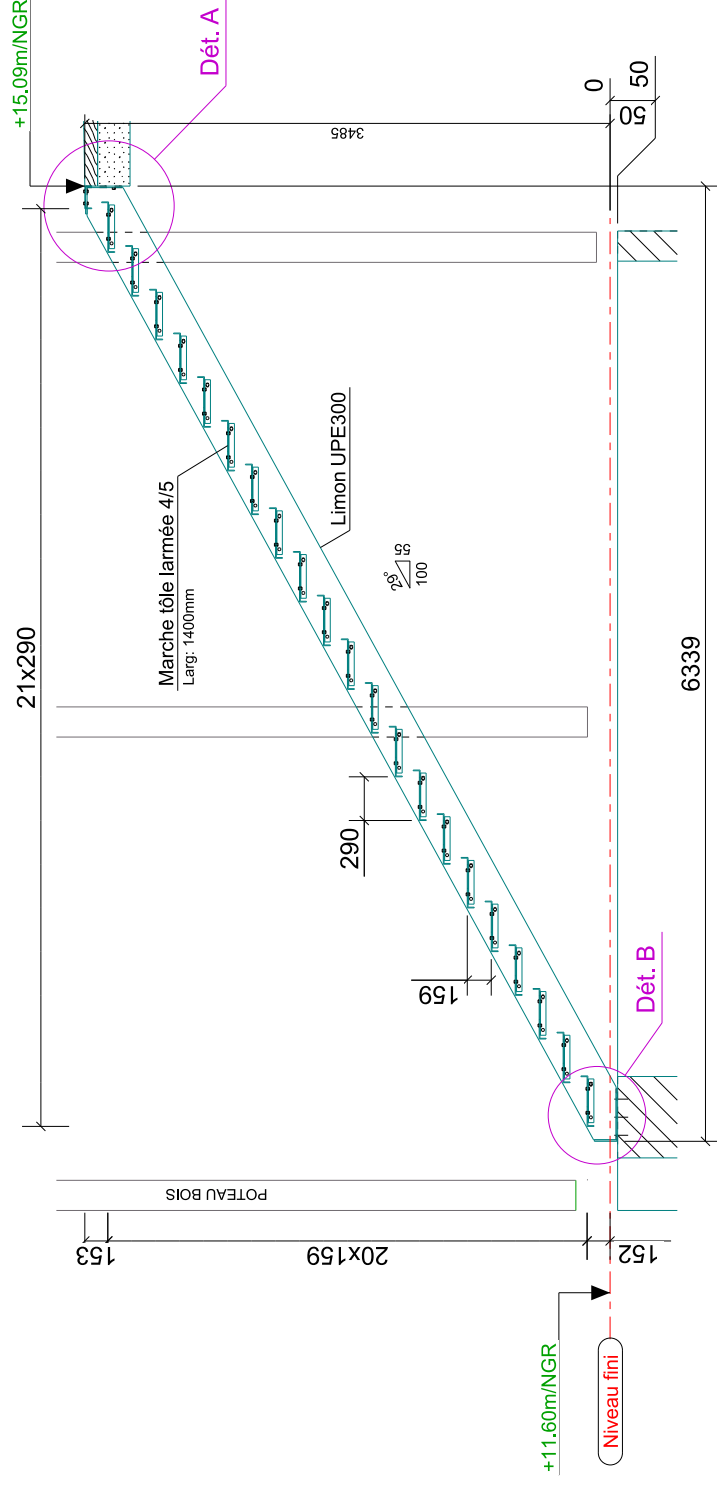

Coupe A - A
1:50

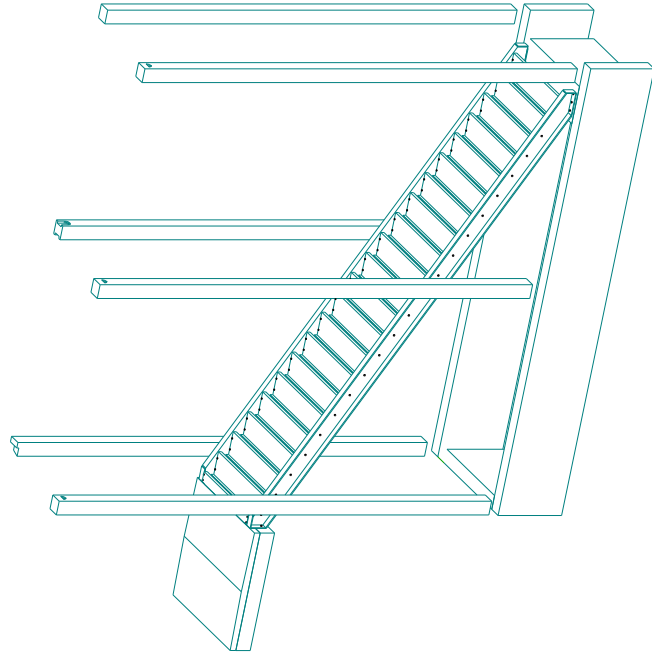
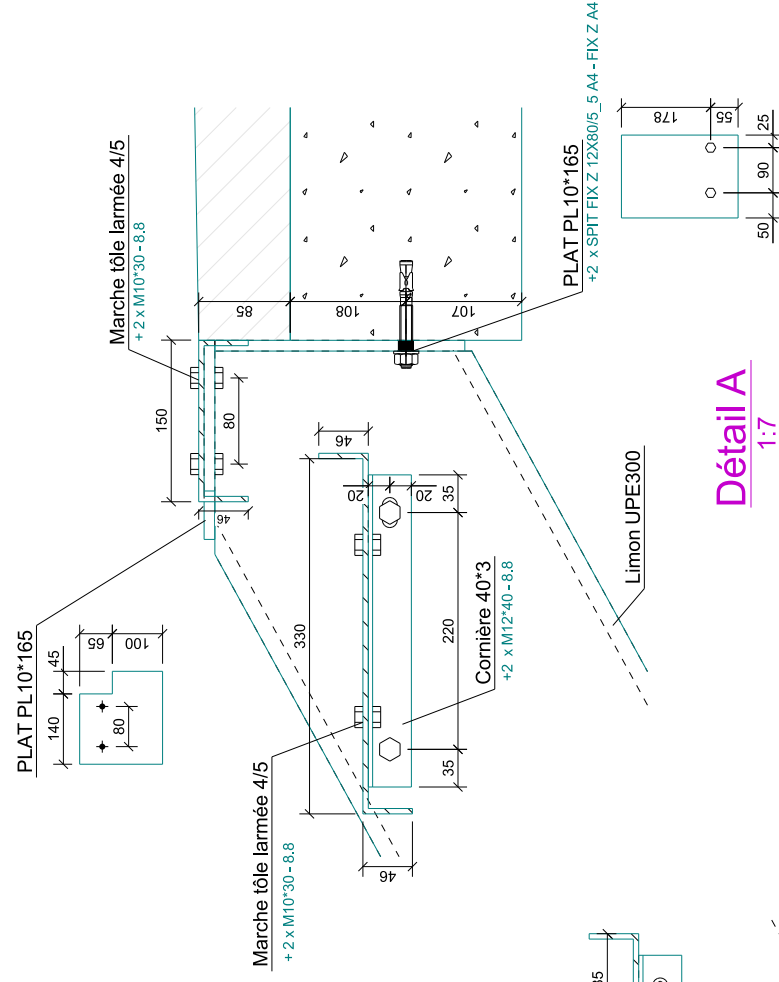

Détail A
1:7

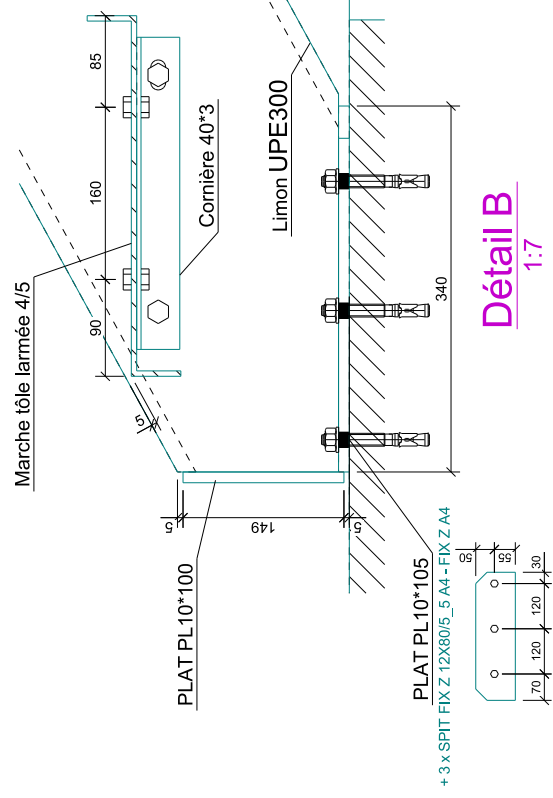

Détail B
1:7

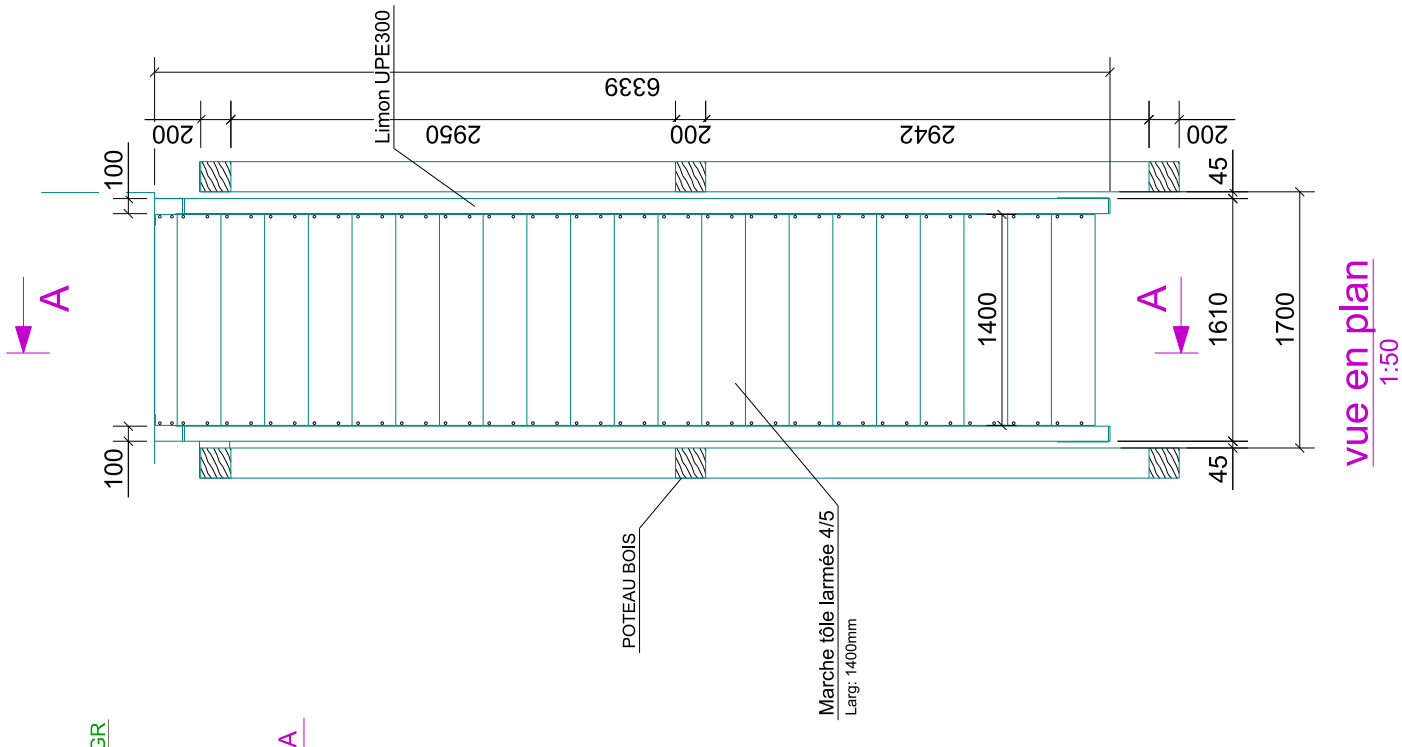

POTEAU BOIS
 Marche tôle larmée 4/5
 Larg: 1400mm

Escalier 2/4 tournant - Bâtiment A - 1/2

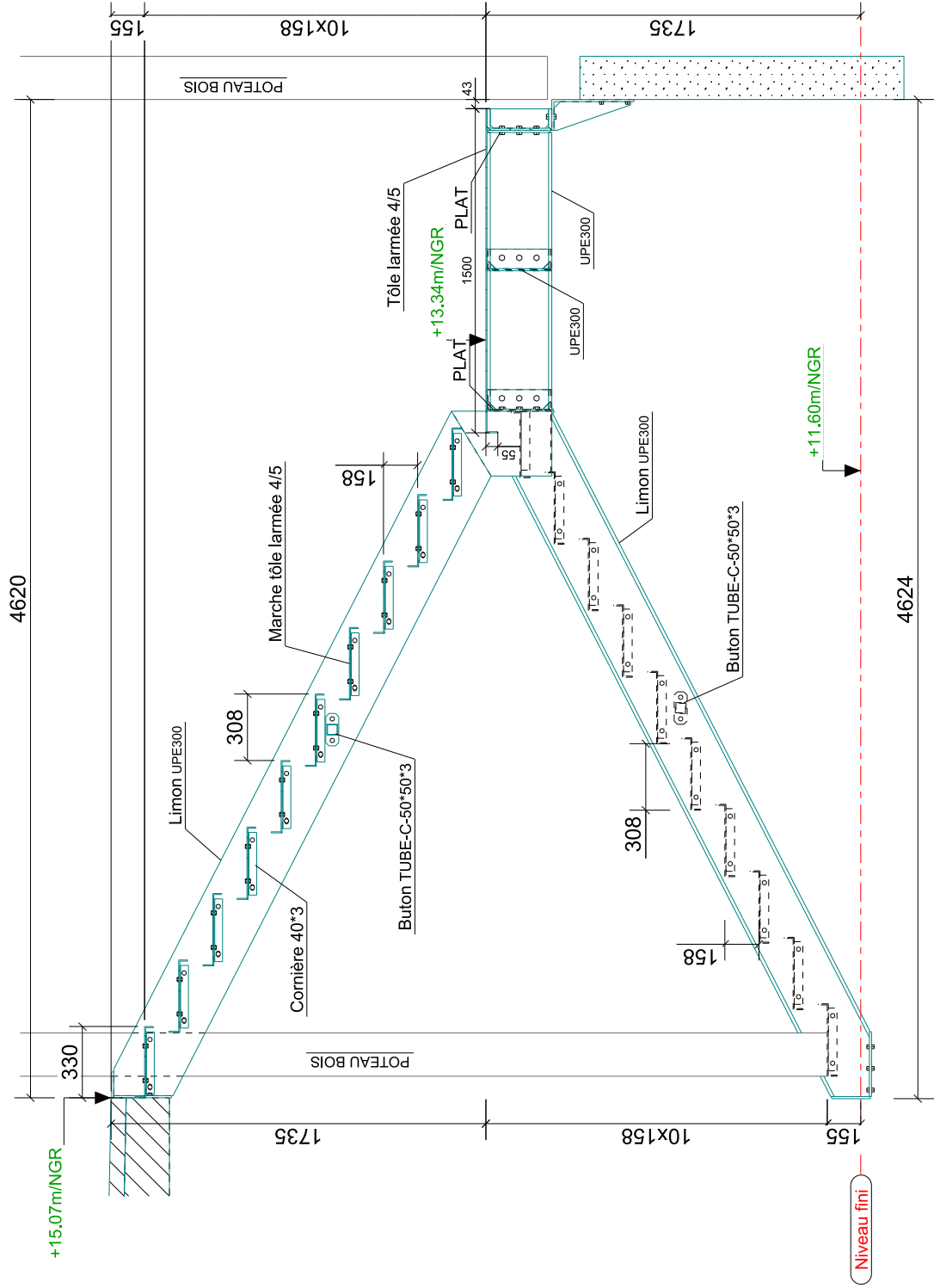

Coupe B - B

1:30

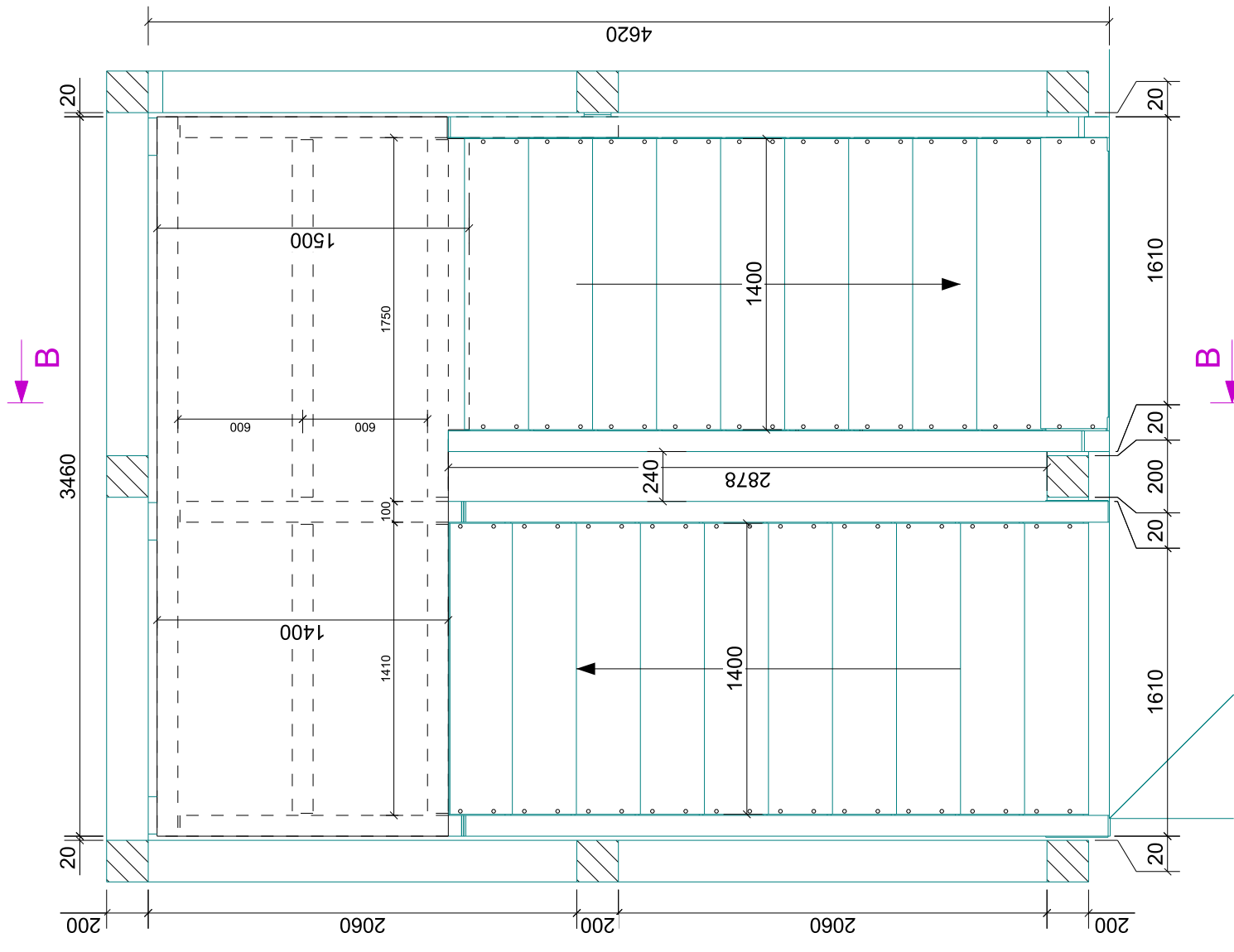
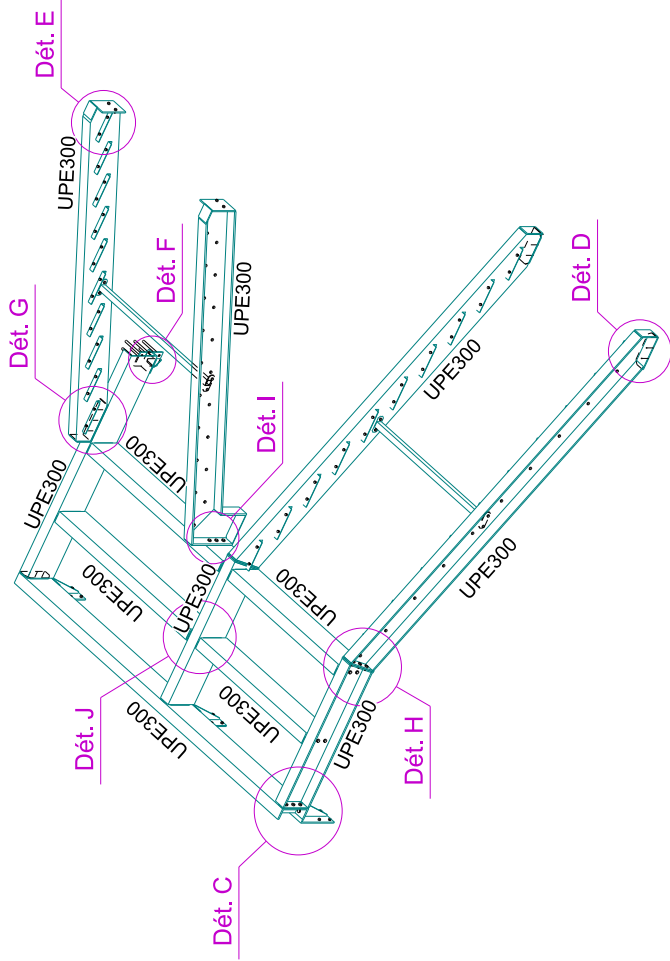

VUE EN PLAN

1:30

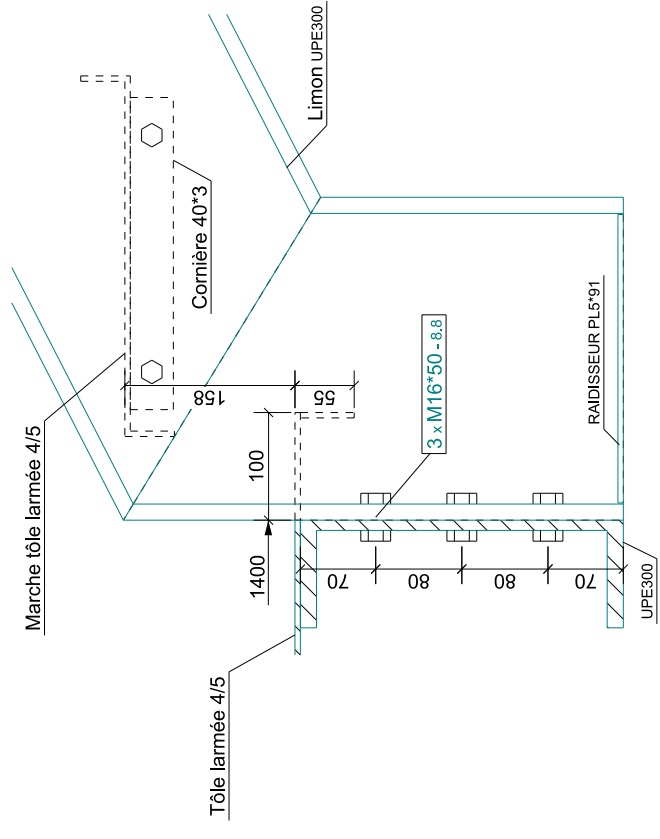

Détail I
1:7

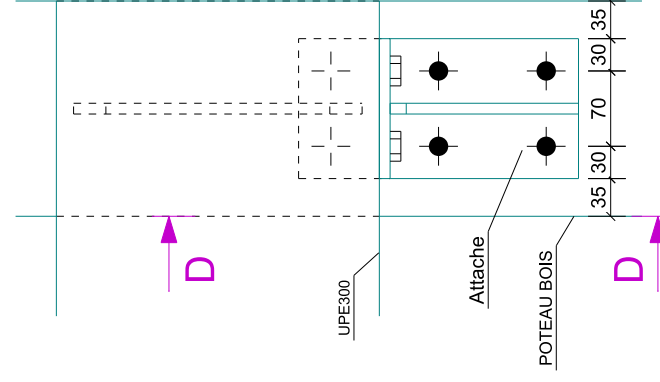

Détail F
1:7

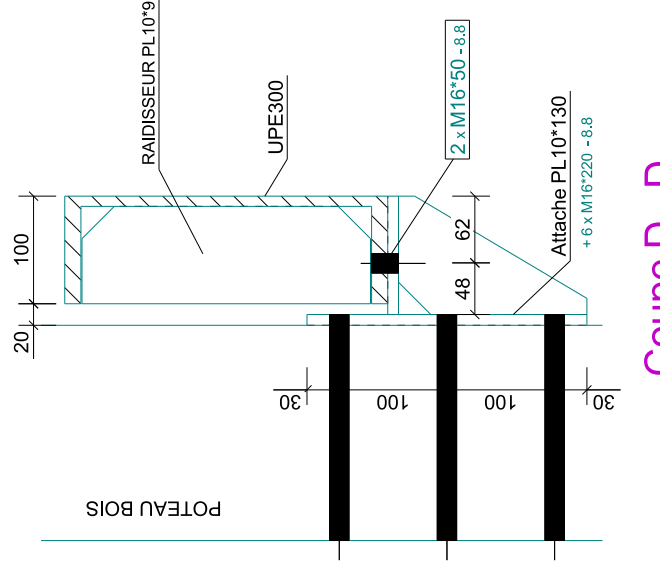

Coupe D - D
1:7

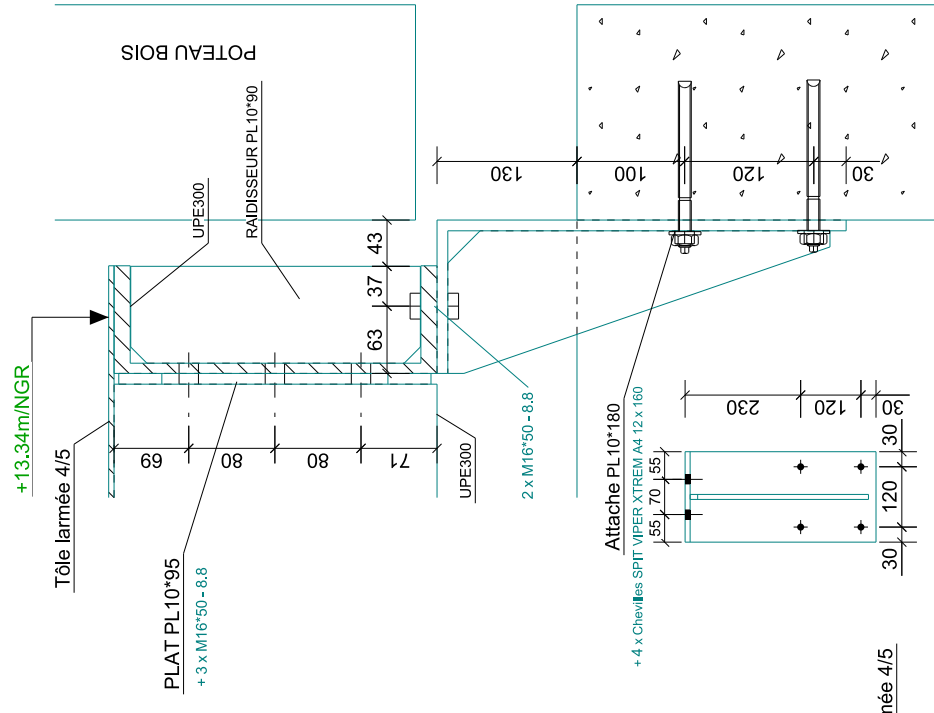

Détail C
1:7

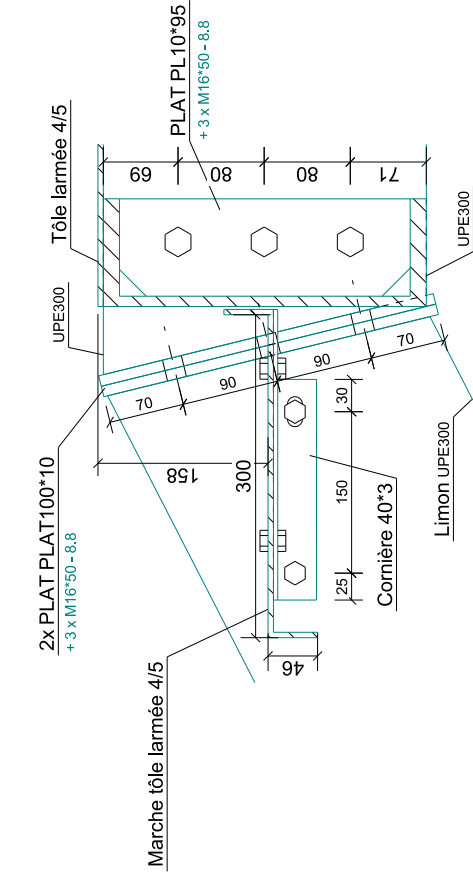

Détail H
1:7

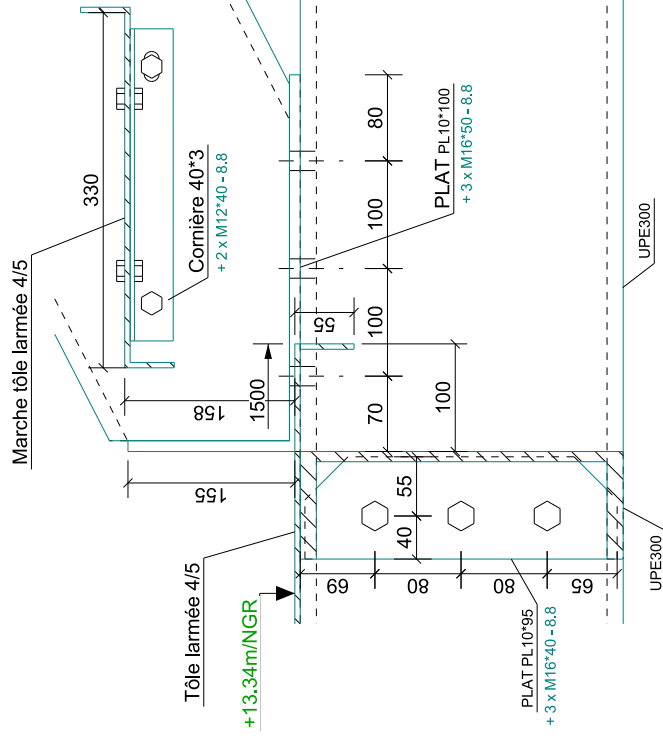

Détail G
1:7

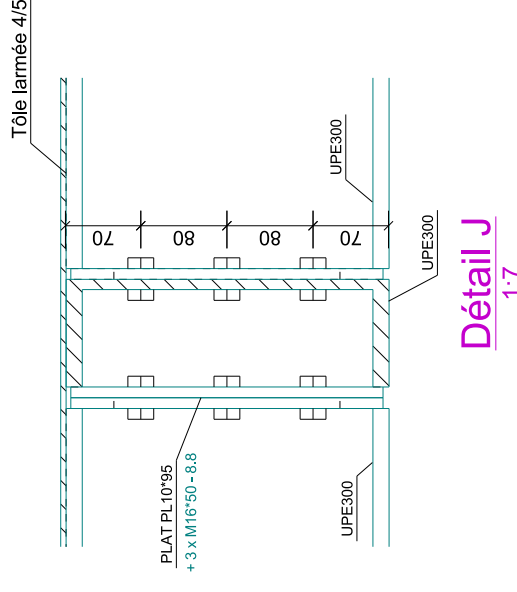

Détail J
1:7

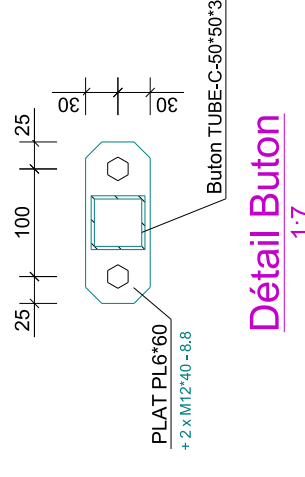

Détail Buton
1:7

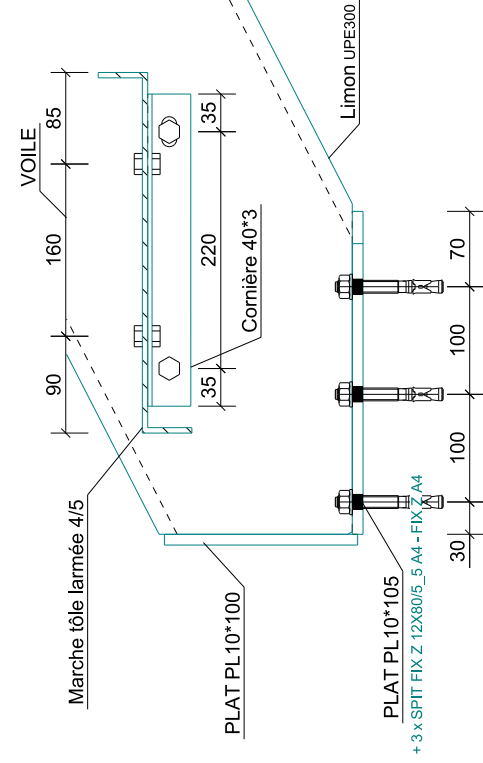

Détail D
1:7

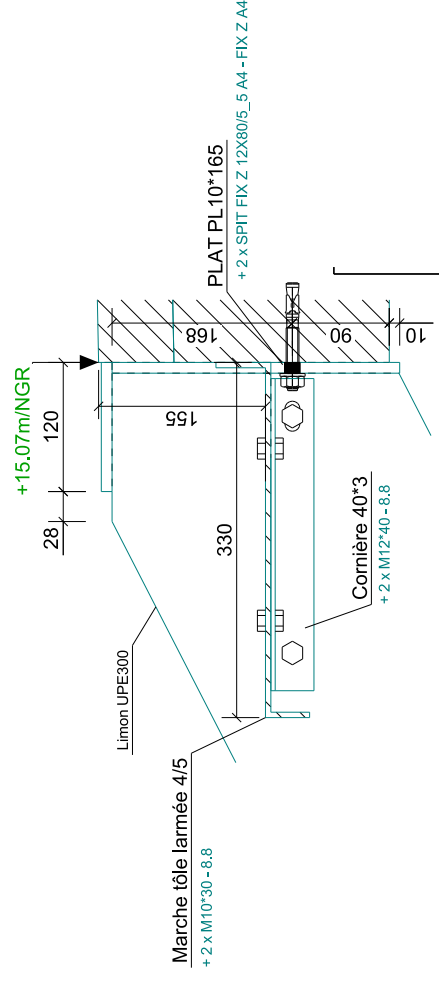

Détail E
1:7

Escalier 2/4 tournant - Bâtiment A - 2/2

Escalier droit - Bâtiment B

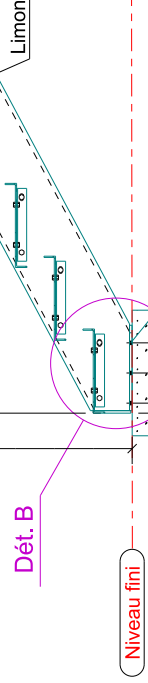
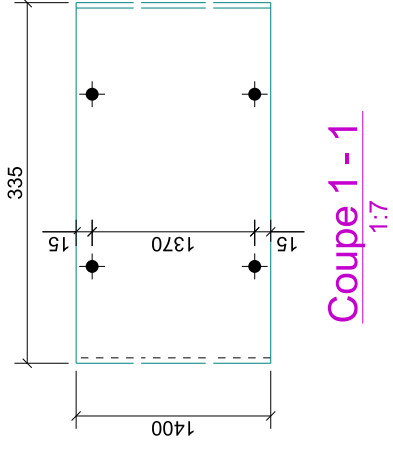
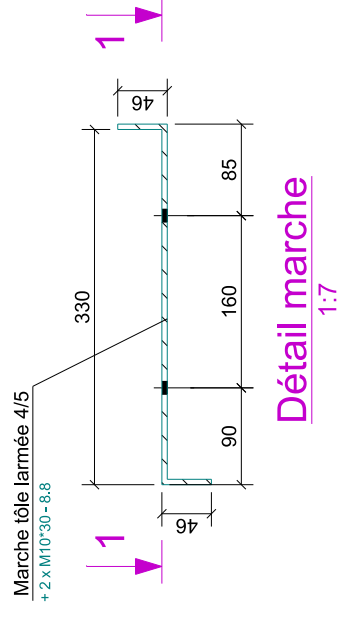
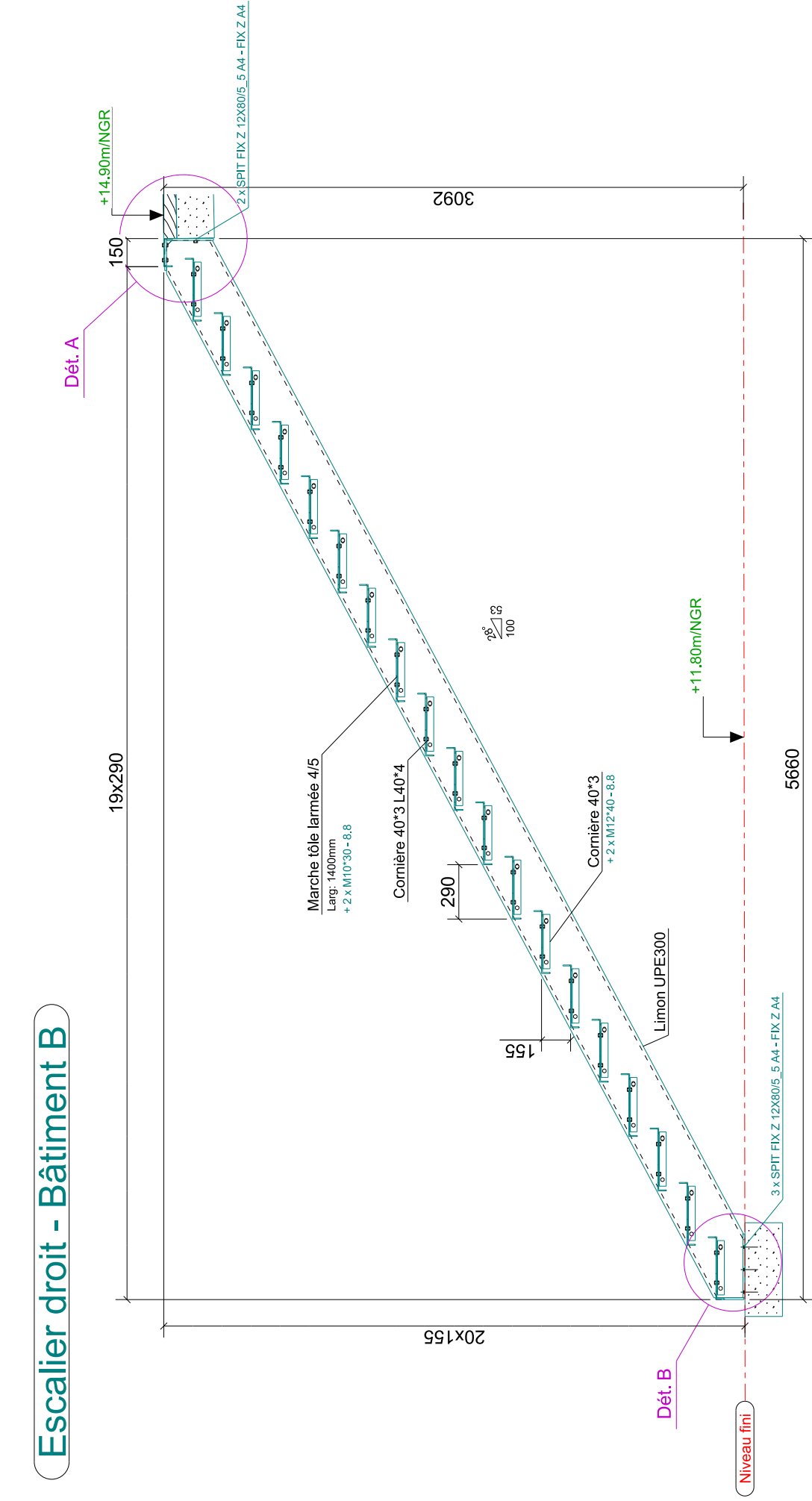

Coupe E - E

1:30

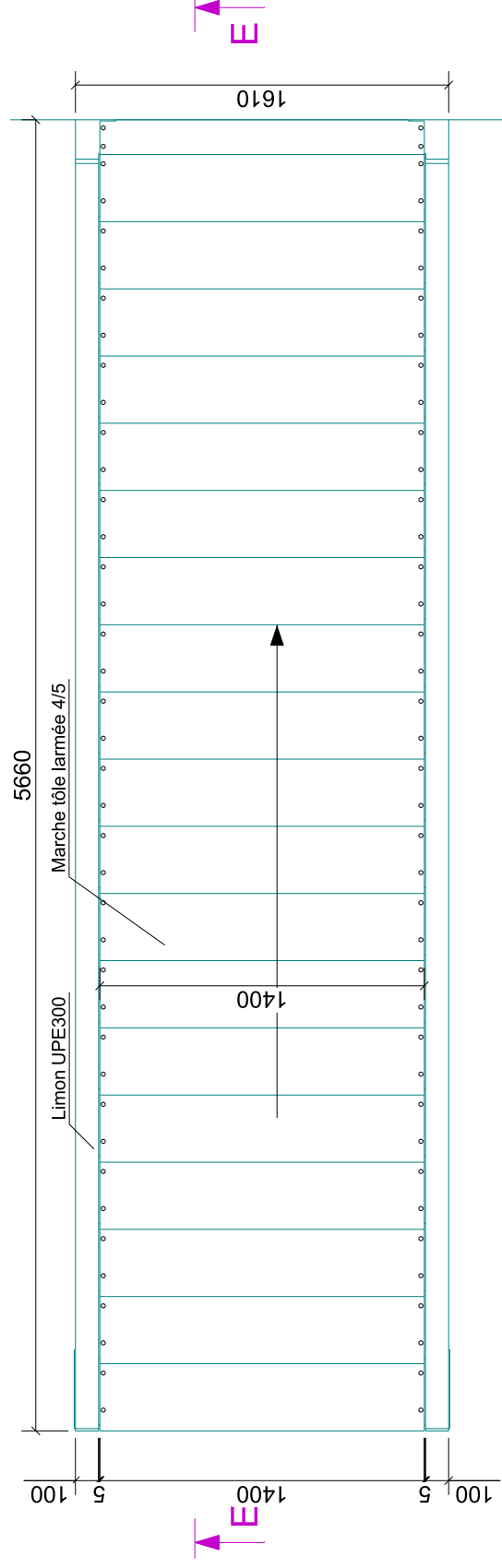

vue en plan

1:30

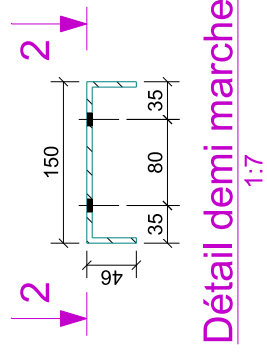
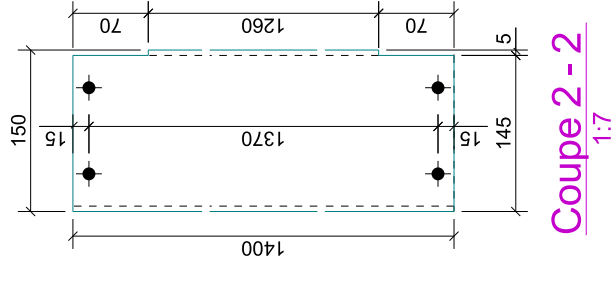

Détail demi marche

1:7

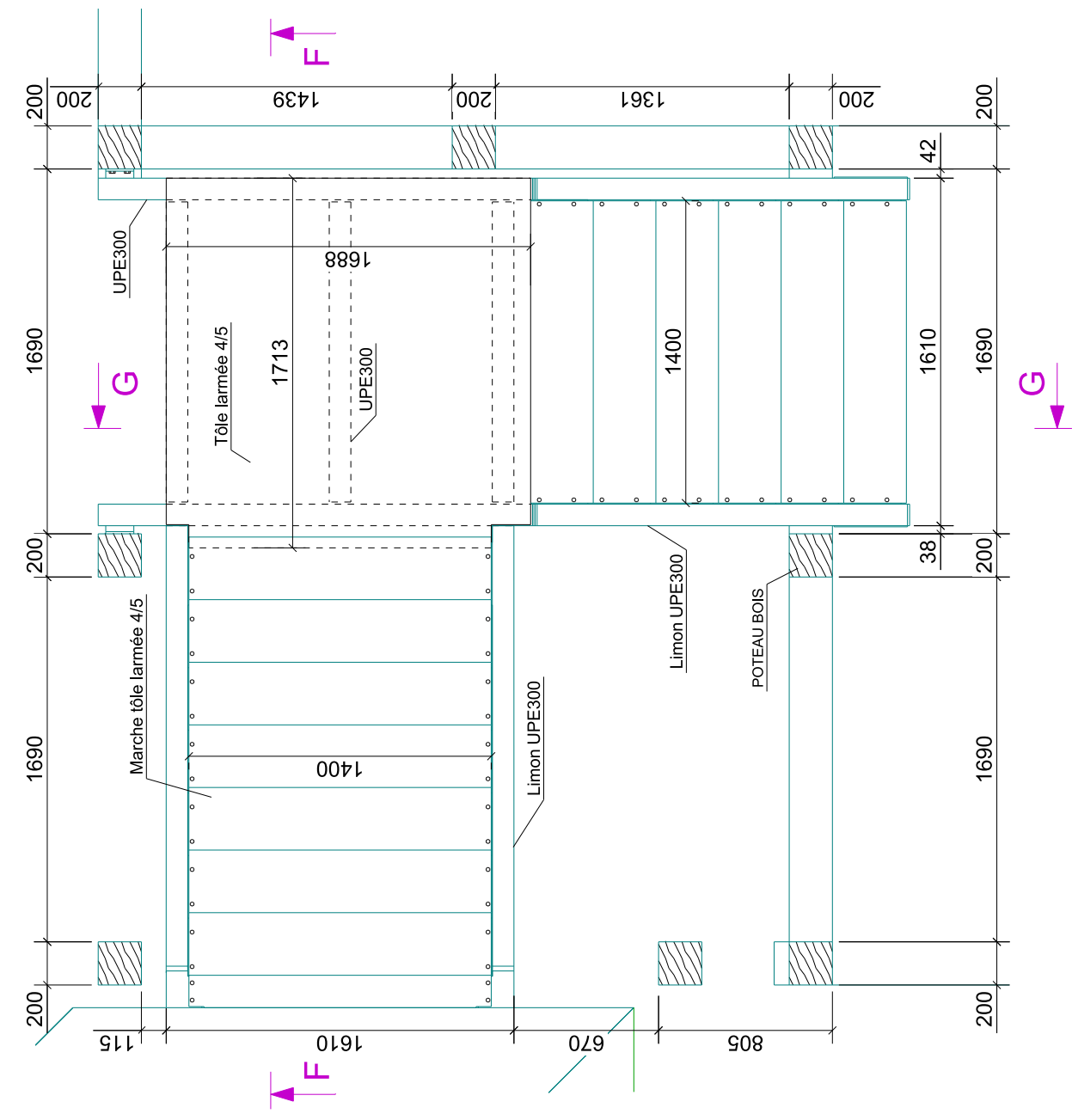

vue en plan
1:30

Escalier 1/4 tournant - Bâtiment B - 1/2

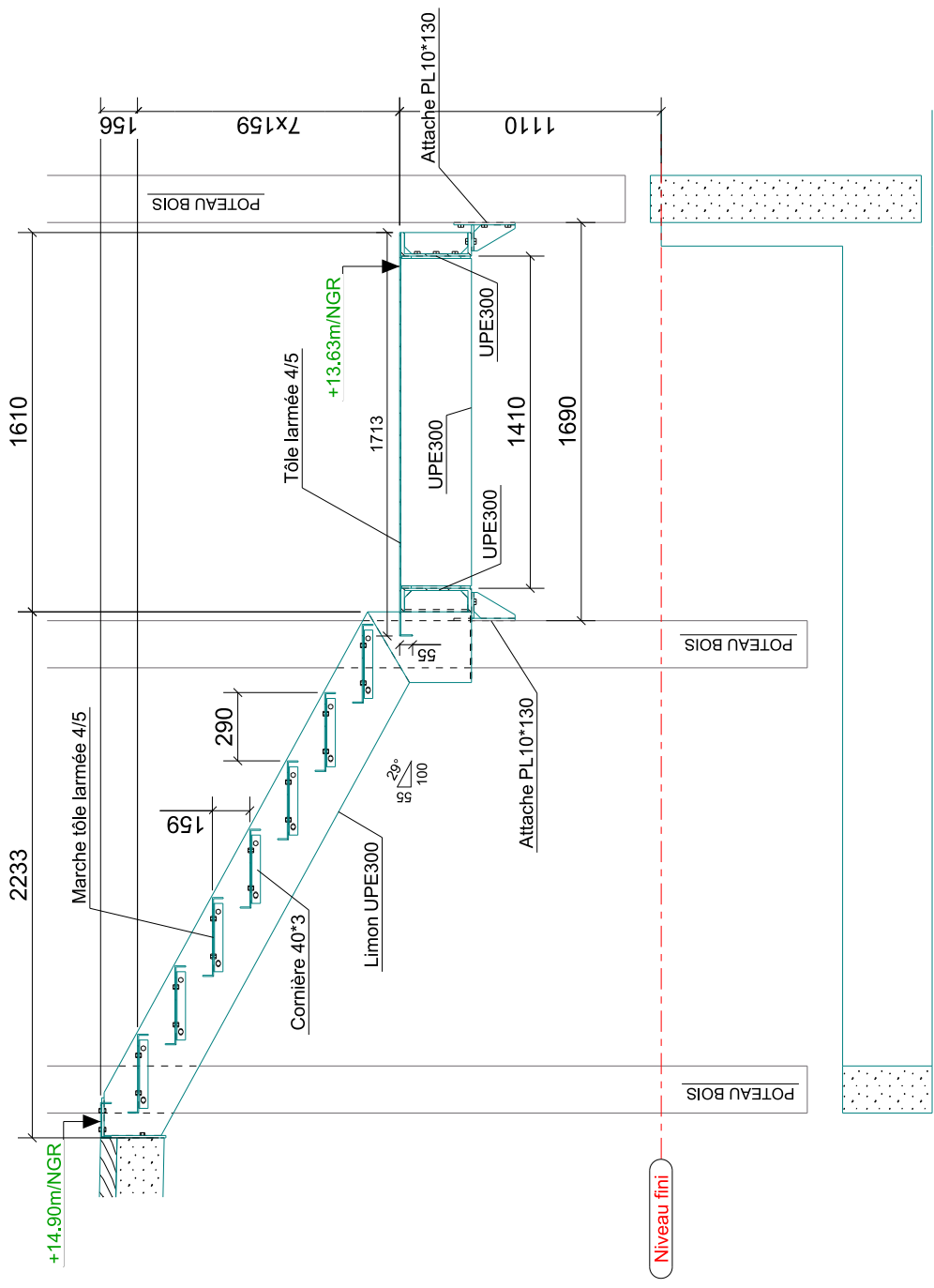

Coupe F - F
1:30

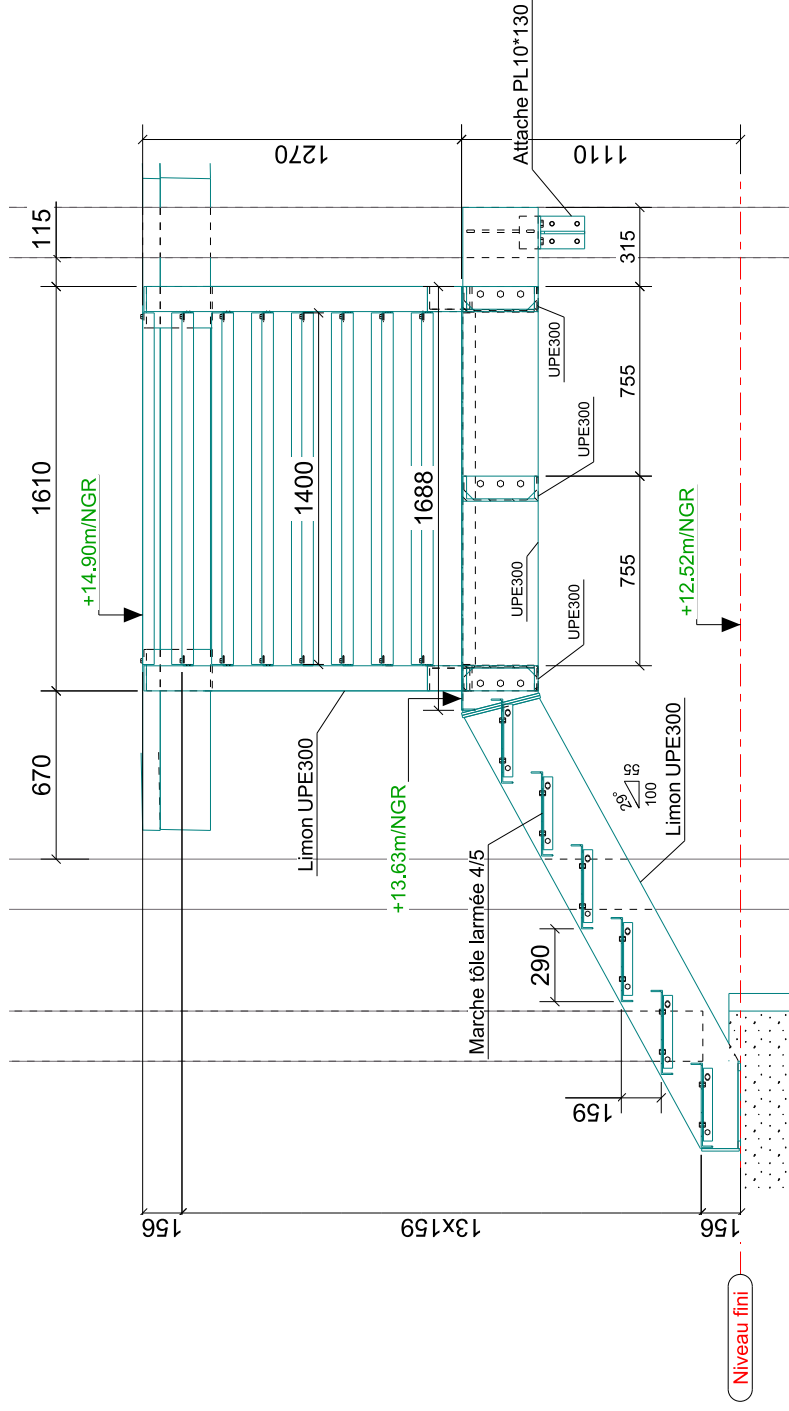

Coupe G - G
1:30

Escalier 1/4 tournant - Bâtiment B - 2/2

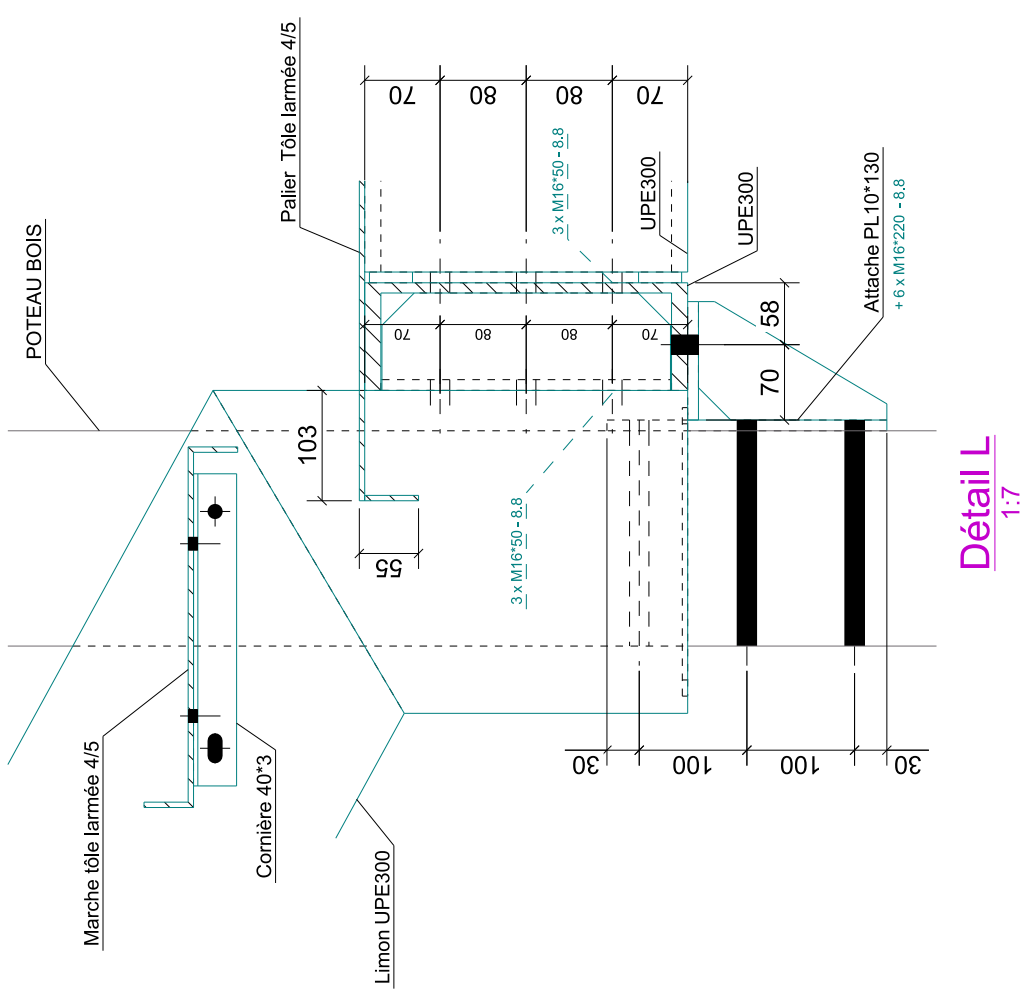

Détail L
1:7

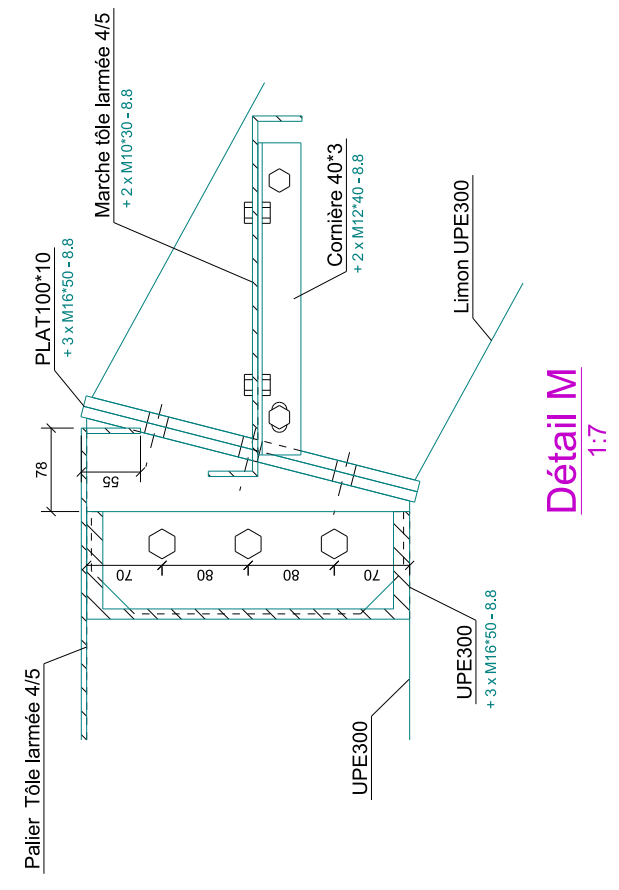
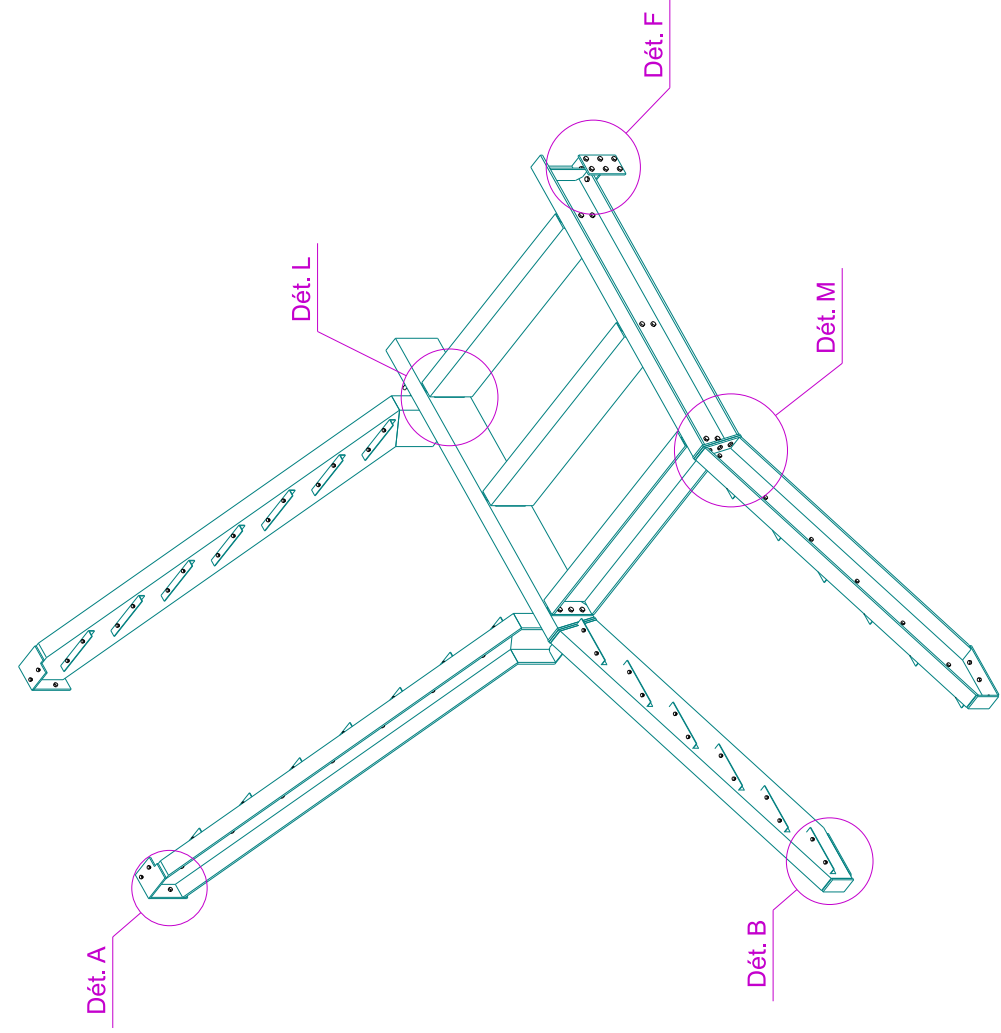

Détail M
1:7